

## Safety Instructions



0,1,2,3,4,6,7,11,15,  
16,17,22,25,

Info Hotline

+49 (0) 5041 998 389

Mon. - Do. 7<sup>00</sup> - 20<sup>00</sup>

Fr. 7<sup>00</sup> - 17<sup>00</sup>



Paulmann Licht GmbH  
31832 Springe /Germany  
www.paulmann.com

Art.-Nr.:

**925.09**  
**925.10**

(+MA 173)

PSU 06/10

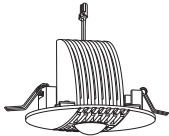

1X

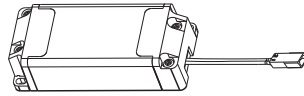

1X



Incl.

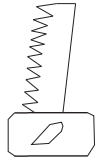

**A**

925.09



(Ø105mm)

925.10



(Ø86mm)

Safety Instructions  
Nr. 0,2

**B**

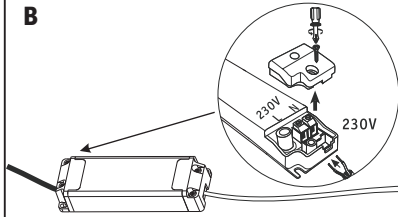

Safety Instructions  
Nr. 0,3,4

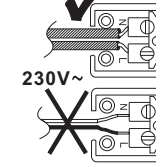
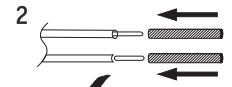
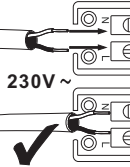
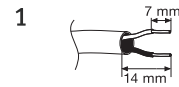

**C**

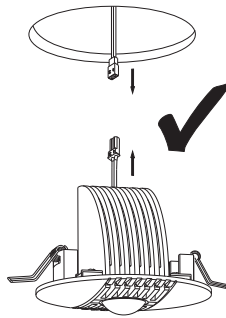
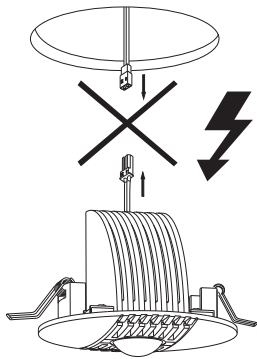
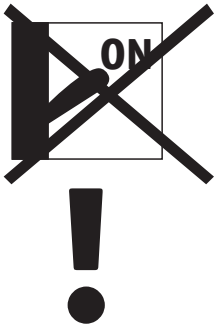

**D**

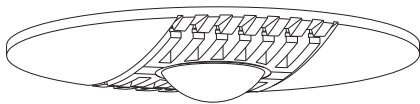
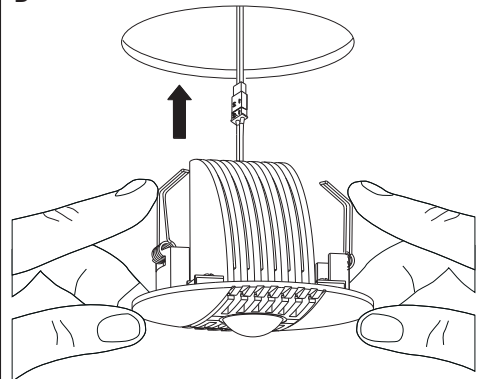

A,B,C,D.....

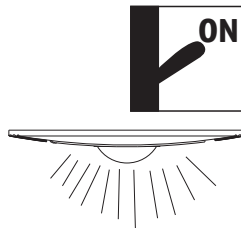

1.

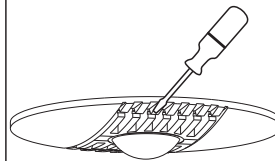

2.

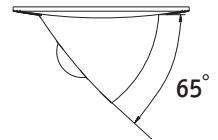

3.

